

CSG9K20GA

9kHz-20GHz Signal Generator



PRODUCT OVERVIEW

Corech Microwave CSG9K20GA series product is our miniaturized signal generators featured with high cost-effectiveness. Frequency ranges from 9kHz to 20GHz, dynamic output power extended from -120dBm to 17dBm. This state of art series of signal generator is excellent for its high spurious, low phase noise, wonderful signal purity and signal stability. Therefore, CSG9K20GA is capable to be applied to the Test & Measurement in the harsh environment of Semiconductor, Quantum Technology, Radar and Communication.



BLOCK DIAGRAM

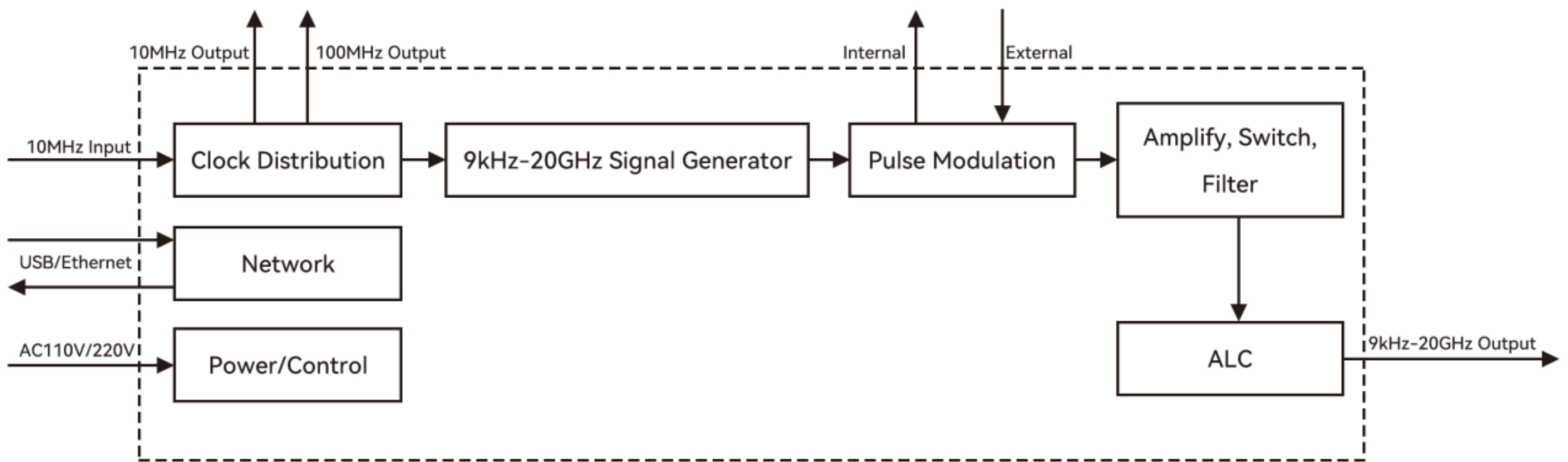

PERFORMANCE

▼ Frequency Range

9kHz ~ 20GHz

▼ Frequency Resolution

0.001Hz

▼ Output Power

-120dBm ~ +17dBm

▼ Amplitude Resolution

0.1dB

▼ Spurious

-80dBc@10GHz

▼ Harmonics

-50dBc@10GHz

▼ Phase Noise

-112dBc/Hz@10kHz(10GHz)

▼ Dimensions

360mm×360mm×89mm

PRODUCT FEATURE

- Cost Effectiveness
- Compact Size
- Low Spurious
- Low Harmonics
- Low Phase Noise
- High Dynamic Output Power



ELECTRICAL SPECIFICATIONS

Parameter	Min.	Typ.	Max.	Note
Frequency Range	9kHz		20GHz	
Frequency Resolution		0.001Hz		
Operating Mode		CW / Sweep		
Frequency Reference				
Internal Reference Aging Rate		±0.3ppm/year		
Initial Calibration Accuracy		±0.1ppm		
External Reference (50Ω)				
Input Frequency		10MHz		
Input Power	+3dBm	+5dBm	+10dBm	
Lock Range		±0.5ppm		
Wave		Sine / Square		
Internal Reference				
Output Frequency		10MHz,100MHz		
Output Power	+5dBm +5dBm		+10dBm +10dBm	Output Freq.: 10MHz Output Freq.: 100MHz
Output Frequency Stability		±0.1ppm		
SSB Phase Noise		-145dBc/Hz@1kHz -155dBc/Hz@1kHz		Output Freq.: 10MHz Output Freq.: 100MHz
Spurious		-70dBc		
Switching Speed				
Sweep		10ms		
Pulse		50ns 120ns		≥100MHz < 100MHz
Output Power				
1GHz	-120dBm		+17dBm	
10GHz	-120dBm		+17dBm	
20GHz	-120dBm		+17dBm	
Output Power Resolution		0.1dB		
Impedance		50Ω		

Parameter	Min.	Typ.	Max.	Note
Harmonics				
1GHz		-50dBc	-40dBc	
10GHz		-55dBc	-40dBc	
20GHz		-45dBc	-40dBc	
1/2 Harmonics				
1GHz		-90dBc	-80dBc	
10GHz		-90dBc	-80dBc	
20GHz		-85dBc	-80dBc	
Spurious (Frequency Offset ≥ 5kHz)				
1GHz		-85dBc	-80dBc	
10GHz		-80dBc	-75dBc	
20GHz		-74dBc	-70dBc	
Pulse Modulation				
On/Off Ratio		-65dBc		
Min. Pulse Width		100ns		
Min. Period		110ns		
External Pulse Input				
LVTTL		+3.3V		
Internal Pulse Generator				
Square Wave Speed Rate	0.1Hz		10MHz	
Period	110ns		100s	
Pulse Width	100ns		99.999999s	
Rise Time		25ns		> 100MHz
Fall Time		25ns		> 100MHz
Resolution		100ns		
Delay	20ns		100s	
Sweep				
Operating Mode		Step Sweep		
Sweep Range	9kHz		20GHz	
Dwell Time	10ms		10s	
Time Resolution		1μs		
Switching Speed		300μs		Internal Source
General Specifications				
Control				Keyboard, Touchscreen, SCPI
Power Requirements	AC110V		AC240V	
Operating Temperature	0°C		+50°C	
Weight			10kg	
Dimensions		360mm×360mm×89mm		Corner Pad Not Included

SSB Phase Noise

Parameters	100Hz	1kHz	10kHz	100kHz	1MHz
dBc/Hz@1GHz	-104	-132	-131	-130	-134
dBc/Hz@10GHz	-84	-109	-112	-111	-115
dBc/Hz@20GHz	-79	-100	-106	-105	-109

Absolute Level Accuracy

Parameters	0dBm < Pout	-20dBm < Pout ≤ 0dBm	-70dBm < Pout ≤ -20dBm	-70dBm ≥ Pout
9kHz < F ≤ 1GHz	≤ ±0.5	≤ ±1.0	≤ ±2.0	≤ ±2.0
1GHz < F ≤ 10GHz	≤ ±0.5	≤ ±1.0	≤ ±2.0	≤ ±2.0
10GHz < F ≤ 20GHz	≤ ±1.0	≤ ±1.0	≤ ±2.0	≤ ±3.0

TYPICAL TEST CURVE

Output Power

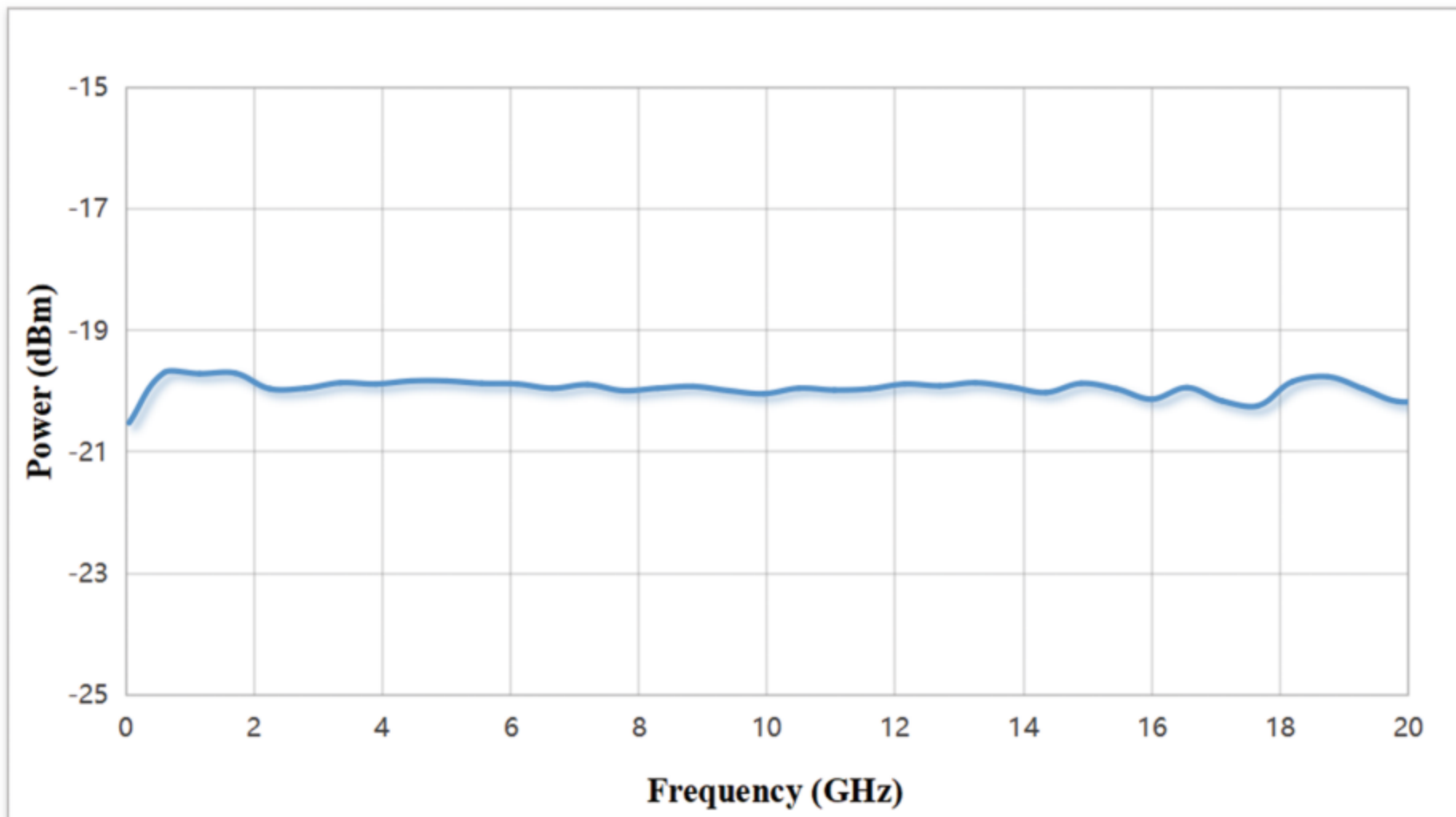

Output Power: -20dBm

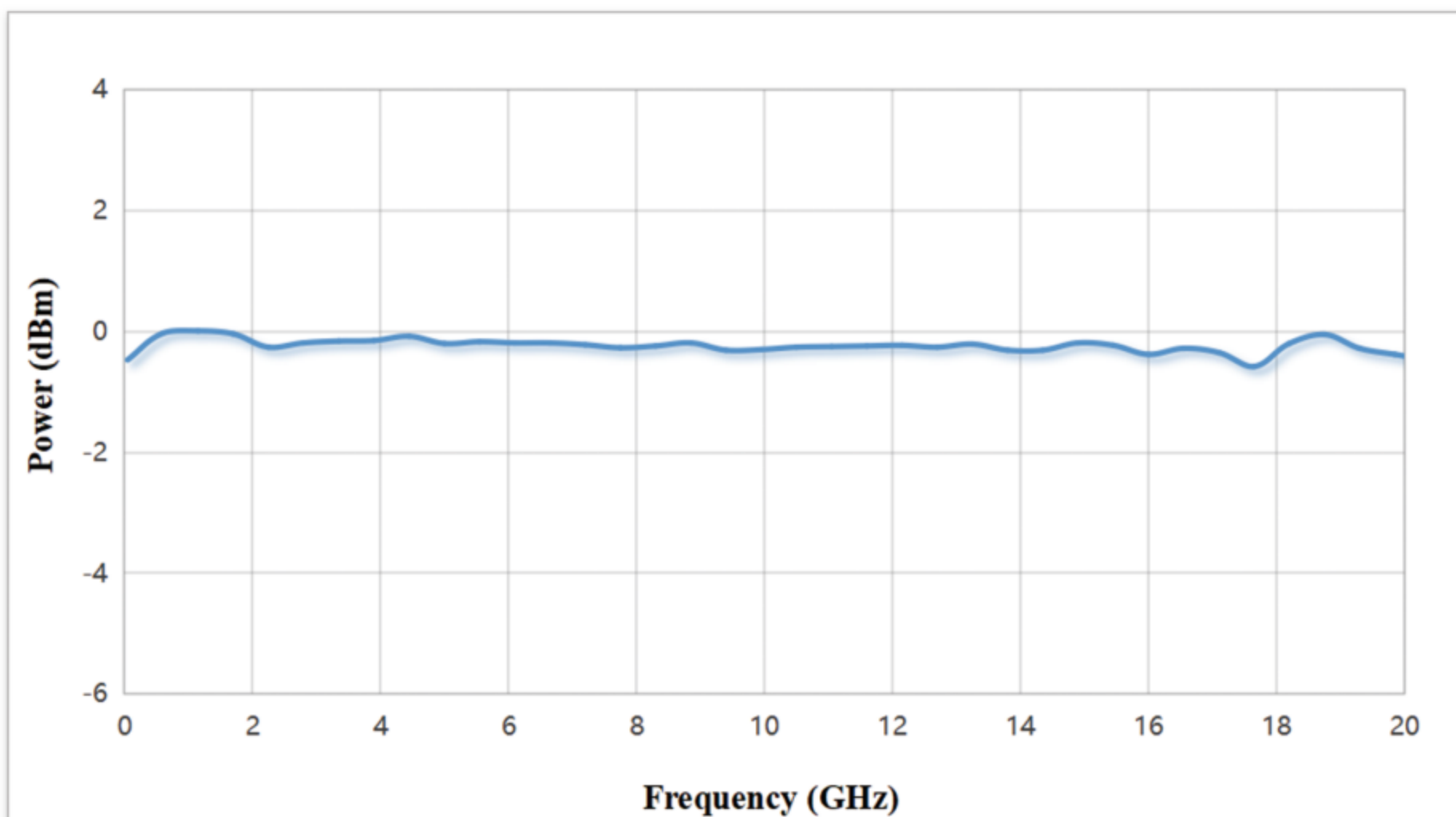

Output Power: 0dBm

Output Power

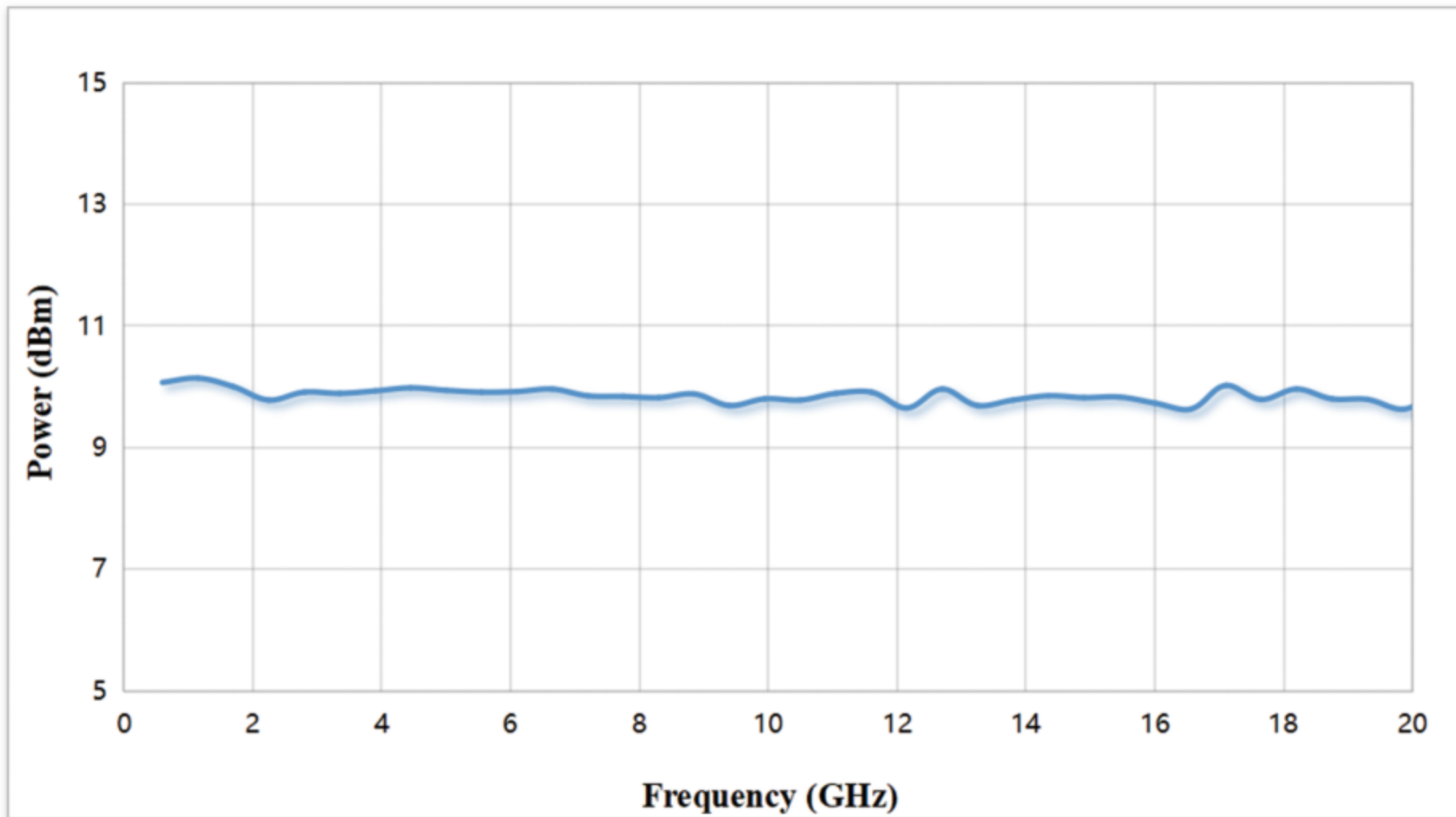

Output Power: +10dBm

SSB Phase Noise

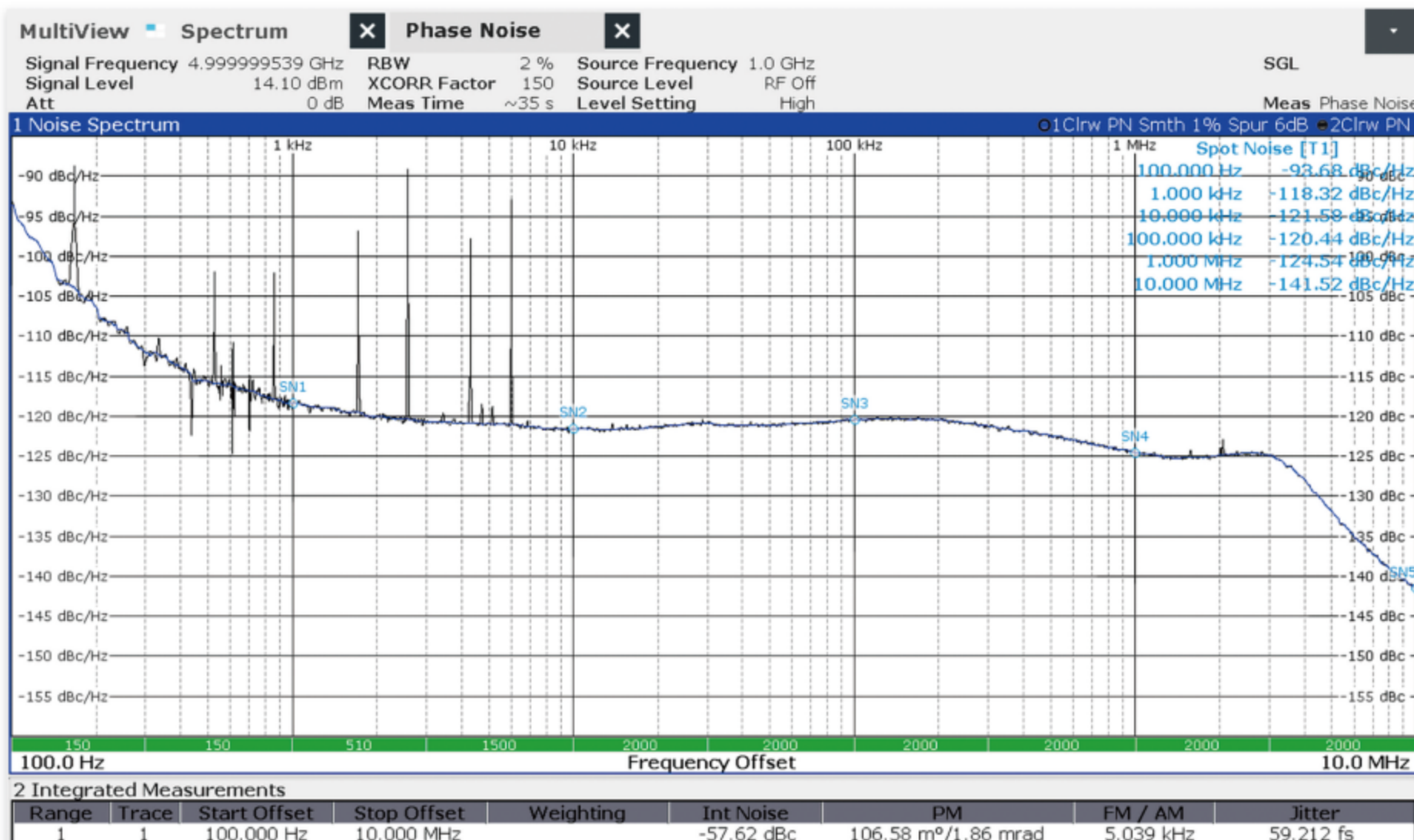

Output Frequency: 5GHz

SSB Phase Noise



Output Frequency: 10GHz



Output Frequency: 20GHz

Spurious

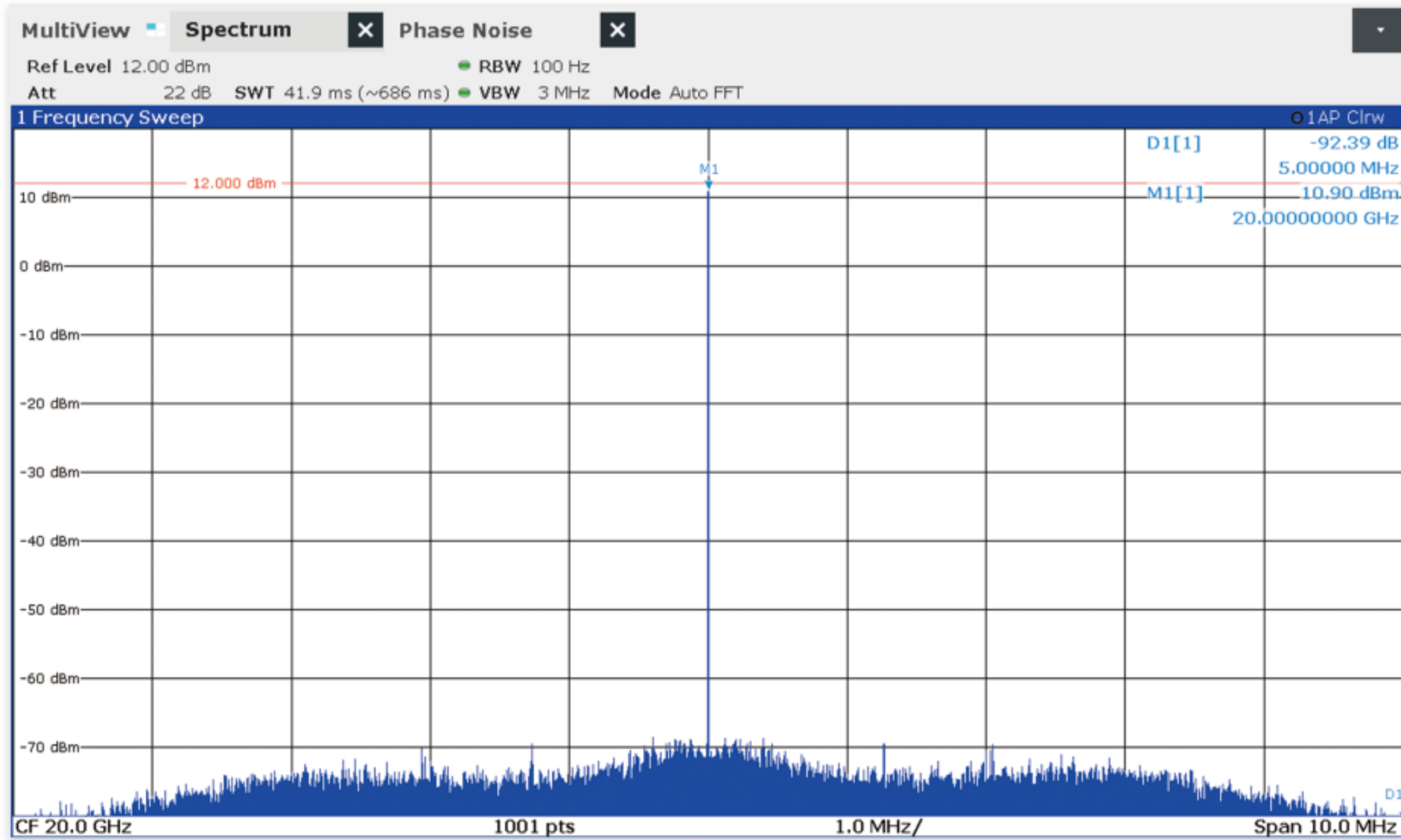

Output Frequency: 20GHz

Harmonics

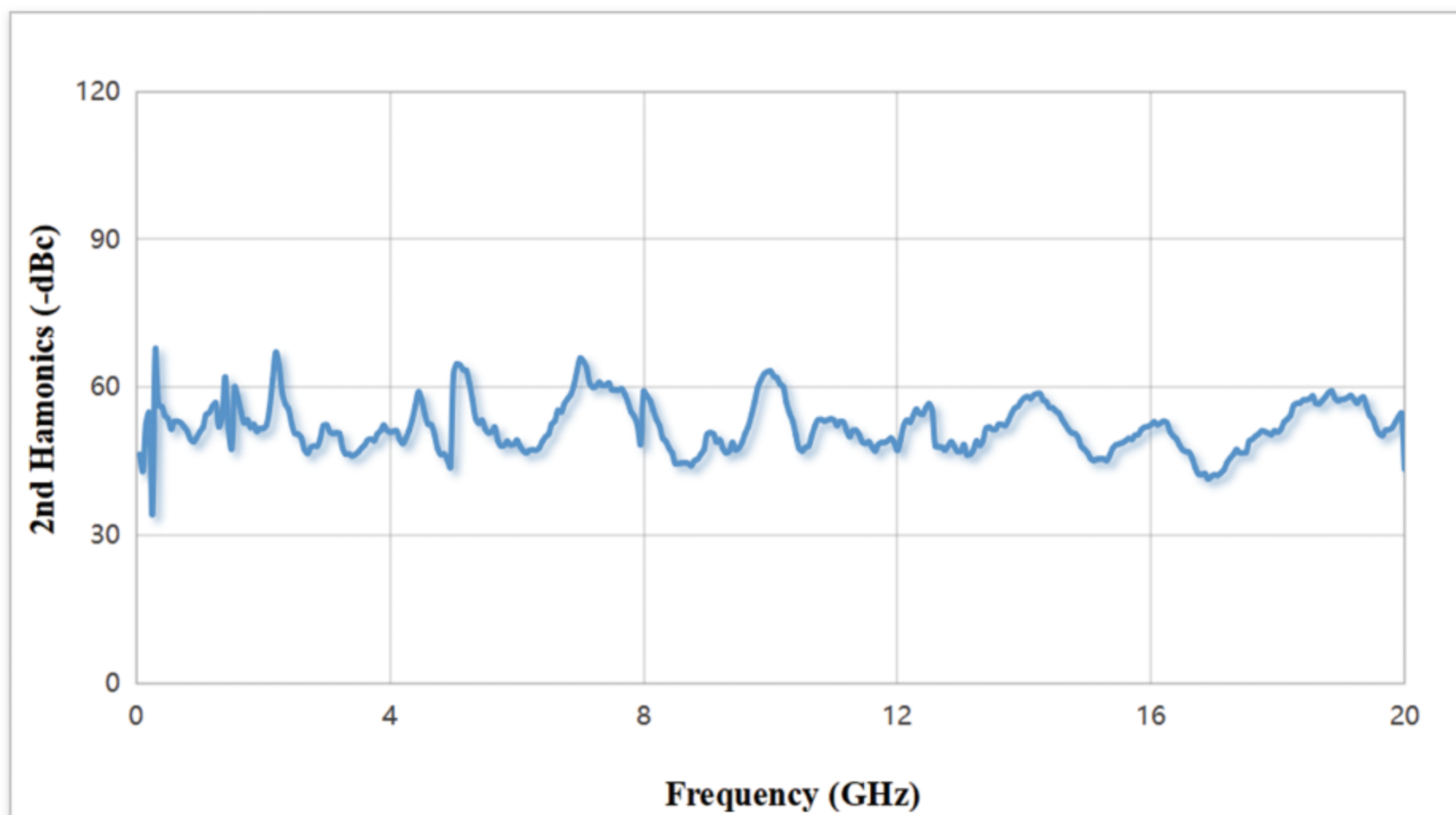

Output Power: +10dBm

Harmonics

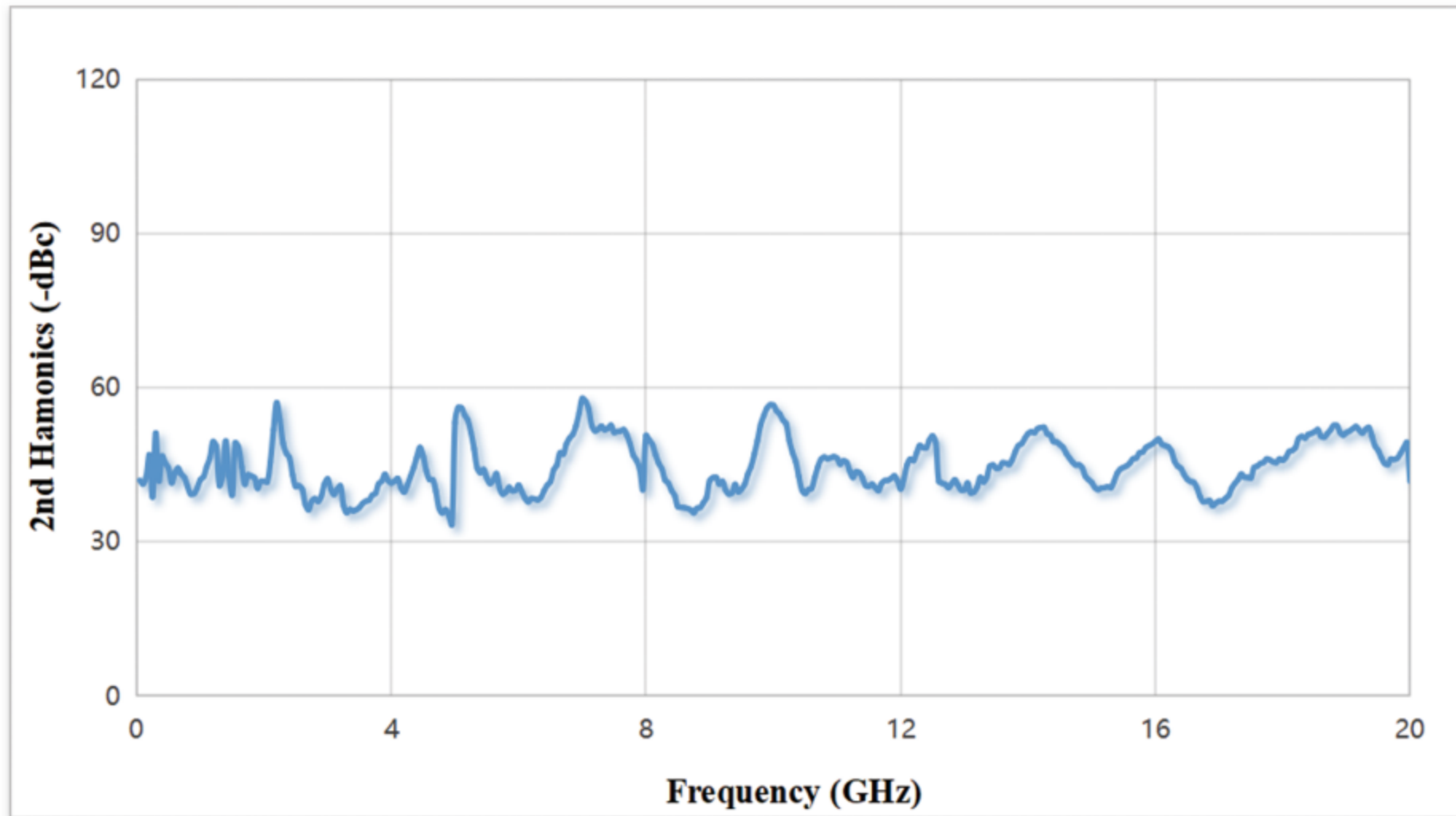

Output Power: +17dBm

1/2 Harmonics

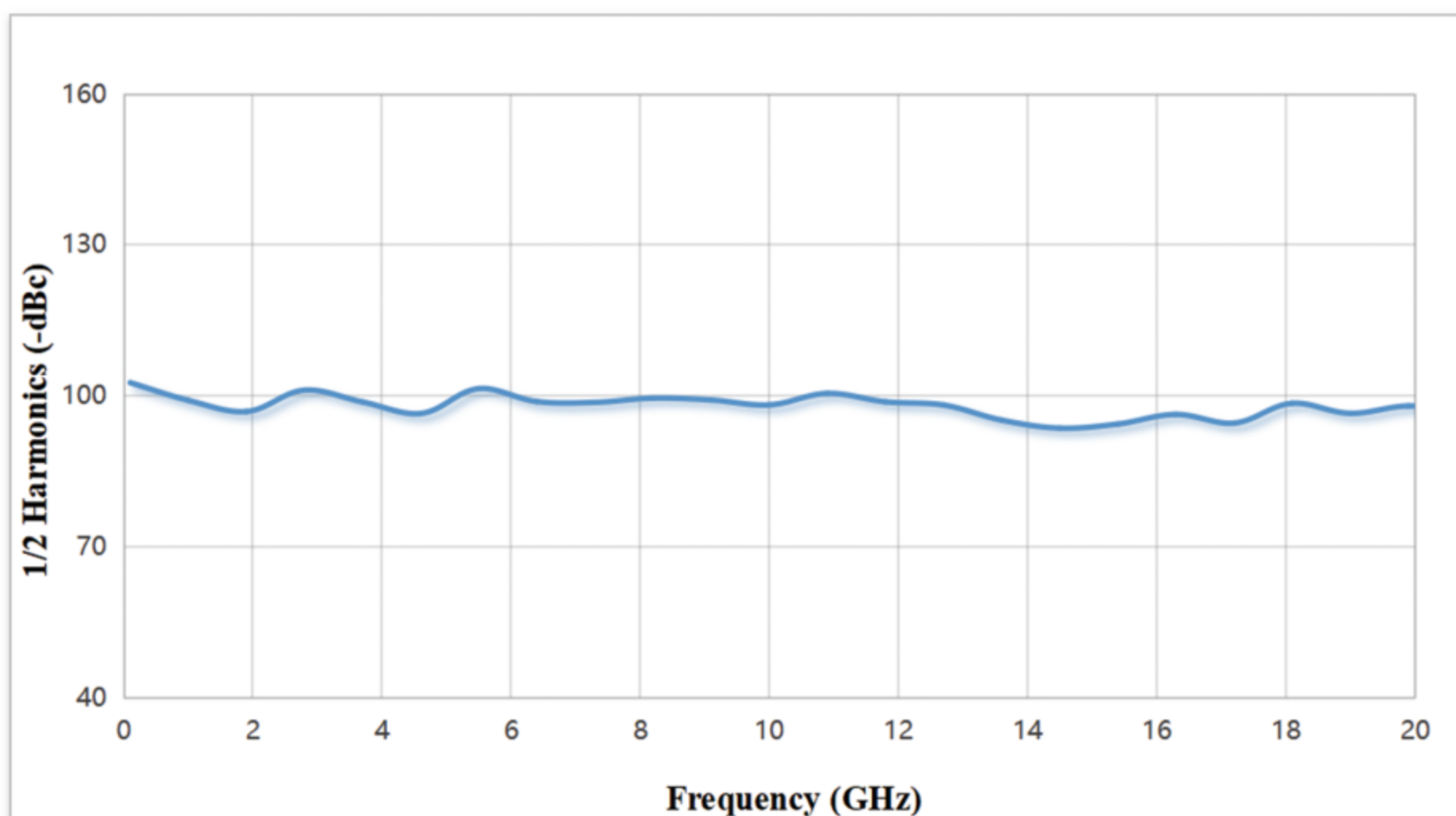

Attenuation Accuracy

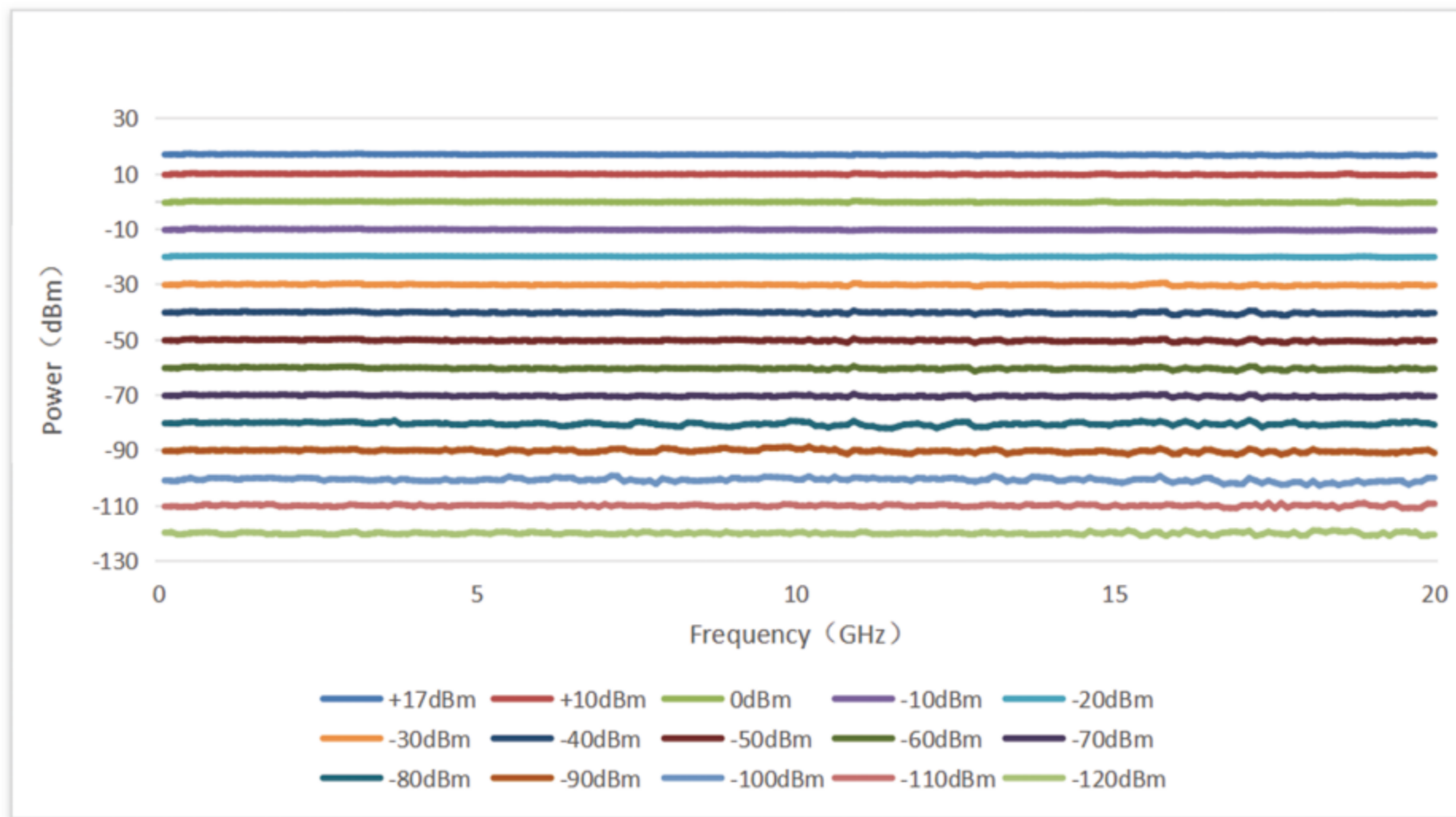

PRODUCT INTERFACE

Front



Ref.	Function	Description
A	DC ON/OFF	
B	RF ON/OFF	
C	Menu	
D	Reset	
E	Keyboard	
F	Knob	
G	RF Output	2.92mm-Male
H	Direction Key	
I	Screen	5.0inch

Back

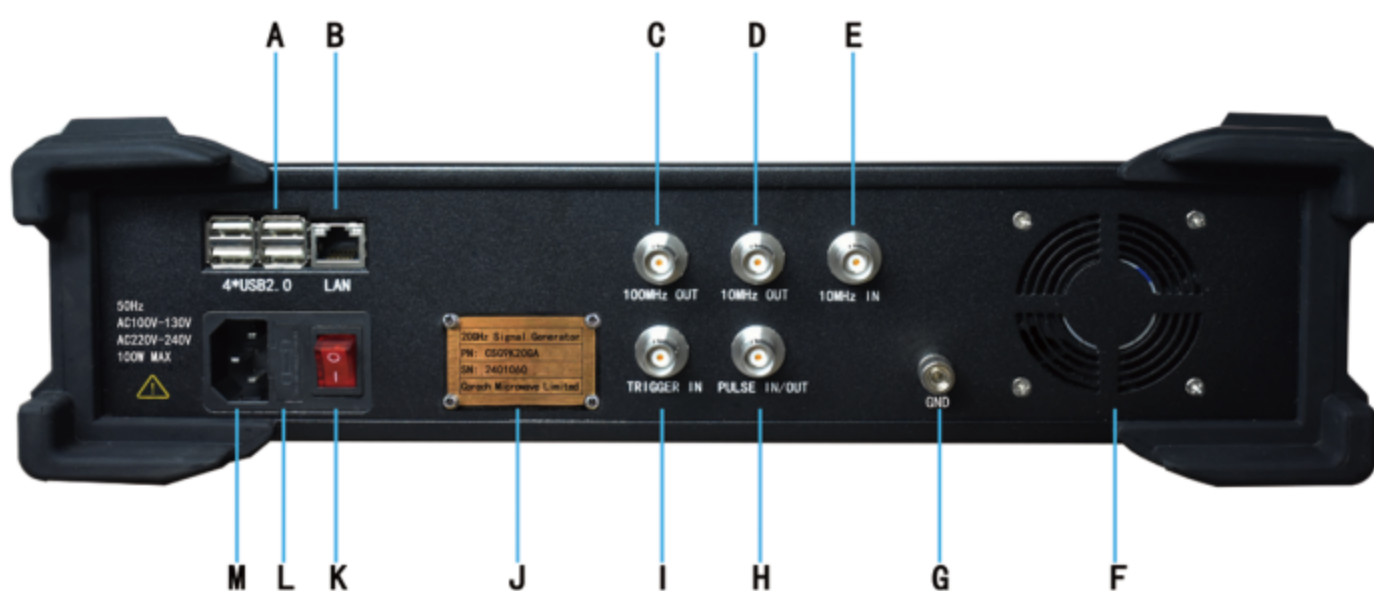

Ref.	Function	Description
A	USB Ports	4xUSB2.0
B	Ethernet Port	RJ45
C	100MHz Output	BNC-Female
D	10MHz Output	BNC-Female
E	10MHz Input	BNC-Female
F	Fan	Exhaust
G	GND Terminal	GND
H	Pulse Signal Input/Output	BNC-Female
I	Trigger Signal In	BNC-Female
J	Name Plate	
K	AC ON/OFF	
L	Fuse Holder	Replaceable
M	AC Power Port	AC110-240V

SCREEN

Frequency PULSE MOD ON SWP ON		Level REF INT		MOD ON	
10.400 000 000 000 GHz		-10.00 dBm		RF ON	
Modulation			Sweep		
Pulse: Period: 20.00 us Width: 5.00 us <input checked="" type="checkbox"/> Mod SW			RF Sweep: Mode: Continuous Start: 10.000 000 000 000 GHz Stop: 20.000 000 000 000 GHz		
Frequency / Level X			Channel Select		
Frequency: 10.000 000 000 000 GHz Level: -10.00 dBm			Channel Select: <input checked="" type="checkbox"/> CH1 On <input type="checkbox"/> CH2 On		
			<input type="button" value="MENU"/>		

Sweep		X
Sweep State	Off	
Sweep Mode	Single	
Start Freq.	10.000 000 000 000	GHz
Stop Freq.	20.000 000 000 000	GHz
Freq. Step	0.100 000 000 000	GHz
Dwell Time	10	ms
Sweep Time	1 010	ms

Options

Model / PN	Description
CSG9K20GA	9kHz-20GHz Single Channel Signal Generator
CSG9K40GA	9kHz-40GHz Single Channel Signal Generator
CSG9K20GD40	9kHz-20GHz & 9kHz-40GHz Dual Channel Signal Generator
CSG9K20GD20	9kHz-20GHz & 9kHz-20GHz Dual Channel Signal Generator
CSG9K40GD40	9kHz-40GHz & 9kHz-40GHz Dual Channel Signal Generator

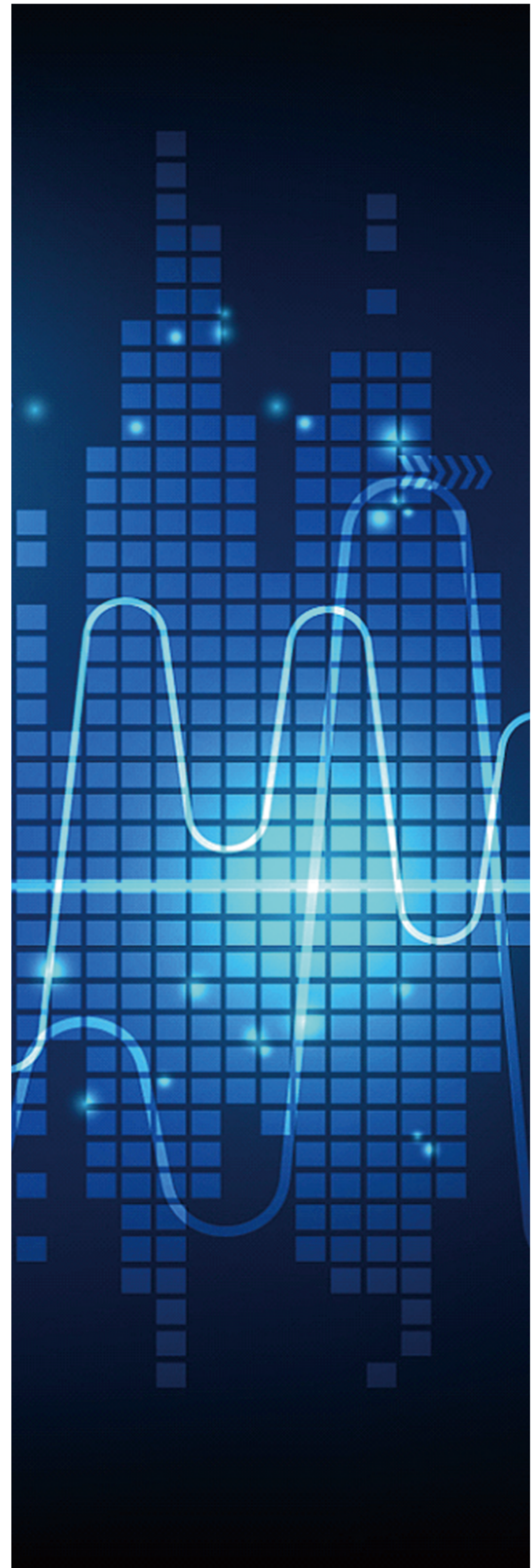

About us

Corech Microwave deliveries one-stop RF solutions for our clients.

Our vision: Passion for the most advanced RF technologies, delivering the most satisfying RF solutions.

With over 15 years of experience, Corech excels in production speed, quality assurance, and cost control. We specialize in providing comprehensive RF solutions, leveraging cutting-edge signal generators to meet customer requirements with reliability and cost-effectiveness. With 25 invention patents and certifications including GJB9001C-2017 and Chengdu High-Tech Enterprise, we uphold the highest standards of quality and innovation.

Corech Microwave | One-stop RF & Microwave Solution



3-Year Warranty

Corech Microwave provides 3-Year Warranty Service for CSG9K20GA series products. Assist our clients on boosting test confidence, reducing cost and enhancing operating convenience.

Contact us

Corech Microwave Limited

Address : No. 166, Wuxing 4th Road, Chengdu, NJ 610000 CHINA

Website : www.corechmw.com

E-mail: info@corechmw.com

Tel : +86 (28) 8705 7896

WeChat : +86 158 2867 7991