

Features

- Design : SPST Absorptive
- Ultra Wide Band
- Low Insertion Loss 5 dB
- Fast Switching Speed
- RoHS and REACH Compliant

Electrical Specifications

Description	Units	Minimum	Typical	Maximum
Freq. Range	GHz	1		40
Input Power	W		0.2	
Insertion Loss	dB		4	5
VSWR	:1		2	2.5
Isolation	dB	40	50	
Switching speed	nsec			50
Rise / Fall time	nsec			
DC Biasing (+5V)	mA		50	
DC Biasing (-5V)	mA		50	
Control Interface			PIN	
Control Type			TTL	
Impedance	Ohms		50	
Operating Temp.	°C	-45		+85

Special Requirements

Note

- Electronic Specification Note : Values at 25deg , sea level. Test indicators will deteriorate at high and low temperature ;
- Switching speed is 50% TTL to 90% RF (T- ON) and 50% TTL to 10% RF (T- OFF) ;
- Rise / Fall time : 10% RF to 90% RF and 90% RF to 10% RF ;

Mechanical Specifications

Dimension L*W*H	20*14*10.2 mm
Input Connector	2.92mm-Female Stainless Steel
Output Connectors	2.92mm-Female Stainless Steel
Weight	15 g
Finishing	Nickel Plated
Environment	Nominal
RoHS / REACH Compliant	✓

Truth Table

Control Input TTL	Signal Path State
E1 or TTL	
0	OFF
1	ON

- TTL Control Voltage : High (1) : 2.8 to 5V
- TTL Control Voltage : Low (0) : 0 to 0.8V
- Low Power cold Switching

CAD Drawing

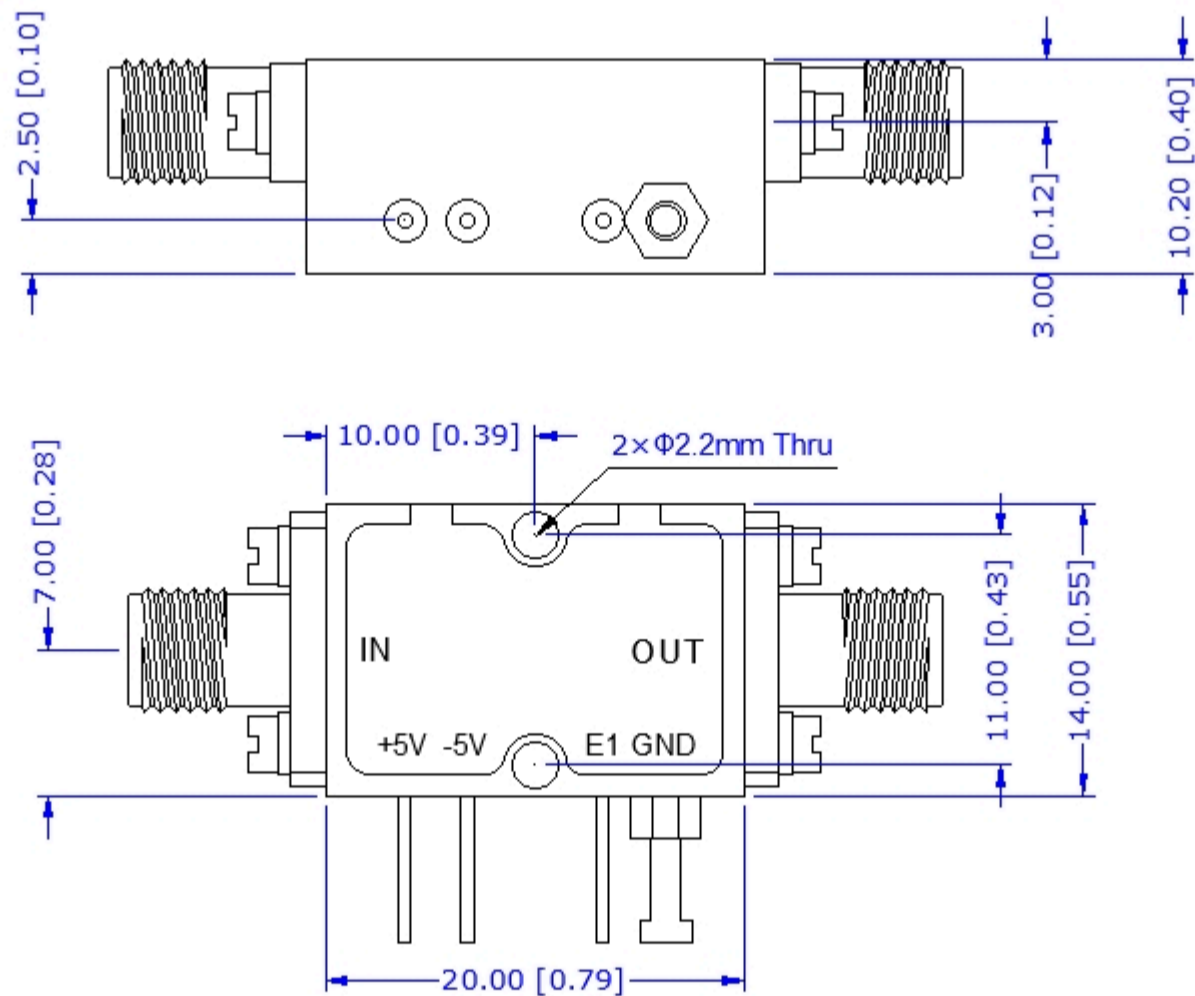

STA02

Dimensions are in mm [Inches]
 Tolerances : Outline drawing: ±0.2 [0.008]
 Hole: ±0.2 [0.008]