

Features

- Design : Wilkinson
- Stainless Steel Connectors
- Low Insertion Loss 3.0dB
- RoHS and REACH Compliant
- High Isolation 18dB

Electrical Specifications

Description	Units	Minimum	Typical	Maximum
Freq. Range	GHz	15		40
Nominal Splitter Loss	dB		6.0	
Insertion Loss	dB			3.0
Input VSWR				2.0
Output VSWR				2.0
Amplitude Balance	dB			1.0
Phase Balance	deg			10
Isolation	dB	18		
Forward Power	W			10
Reverse Power	W			-
Peak Power	KW			0.5
Impedance	Ohms		50	
Operating Temp.	°C	-40		+70

Special Requirements

Note

- Electronic Specification Note : Values at 25deg , sea level. Test indicators will deteriorate at high and low temperature ;
- All output ports /power combiner in-amplitude (0dB difference) ;
- All output ports /power combiner in-phase (0° difference) ;

Mechanical Specifications

Dimension L*W*H	52*35*12.7 mm
Input Connector	2.92mm-Female Stainless Steel
Output Connectors	2.92mm-Female Stainless Steel
Weight	TBD g
Finishing	Paint Black
Environment	Nominal

Compliance Certifications

RoHS Compliant	✓
REACH Compliant	✓

CAD Drawing

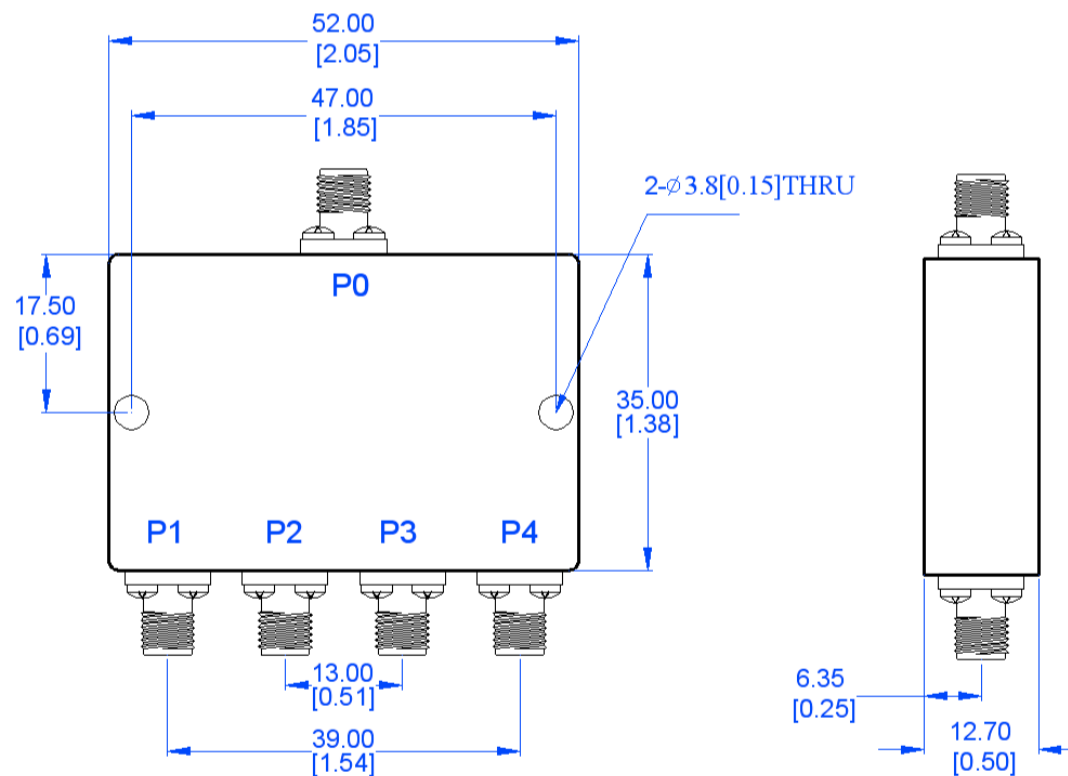

Dimensions are in mm [Inches]
 Tolerances : Outline drawing: ±0.2 [0.008]
 Hole: ±0.2 [0.008]