

Features

- Low Phase Balance 10dB
- Low Insertion Loss 0.8dB
- Low Amplitude Balance 1.2dB
- RoHS and REACH Compliant
- High Isolation 16dB

Electrical Specifications

Description	Units	Minimum	Typical	Maximum
Freq. Range	GHz	6		18
Phase Difference	deg		90	
Insertion Loss	dB			0.8
VSWR				1.5
Amplitude Balance	dB			1.2
Phase Balance	deg			10
Isolation	dB	16		
Input Power (CW)	W			30
Input Power (Peak)	KW			0.5
Impedance	Ohms		50	
Operating Temp.	°C	-45		+85

Special Requirements

Note

- Electronic Specification Note : Values at 25deg , sea level. Test indicators will deteriorate at high and low temperature ;
- Insertion Loss : Excludes Coupling loss insertion loss ;
- Relative Humidity 5 to 95% ;

Mechanical Specifications

Dimension L*W*H	25.4*12.7*12.7 mm
Input Connector	SMA-Female Stainless Steel
Output Connectors	SMA-Female Stainless Steel
Weight	20 g
Finishing	[F8YL9F8]
Environment	Paint Black

Compliance Certifications

RoHS Compliant	Nominal
REACH Compliant	Nominal

CAD Drawing

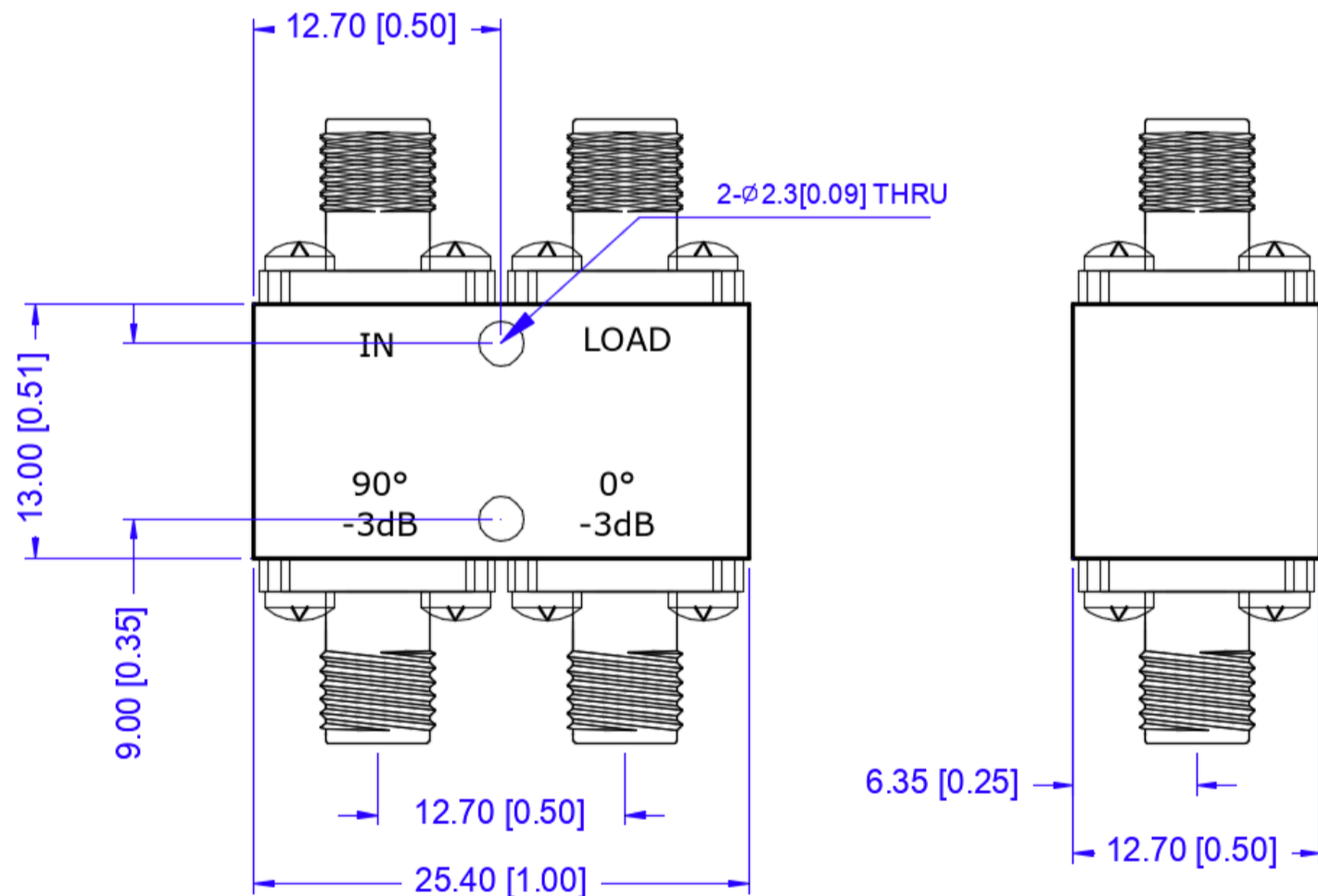

Dimensions are in mm [Inches]
 Tolerances : Outline drawing: ±0.2 [0.008]
 Hole: ±0.2 [0.008]

Input Port VSWR

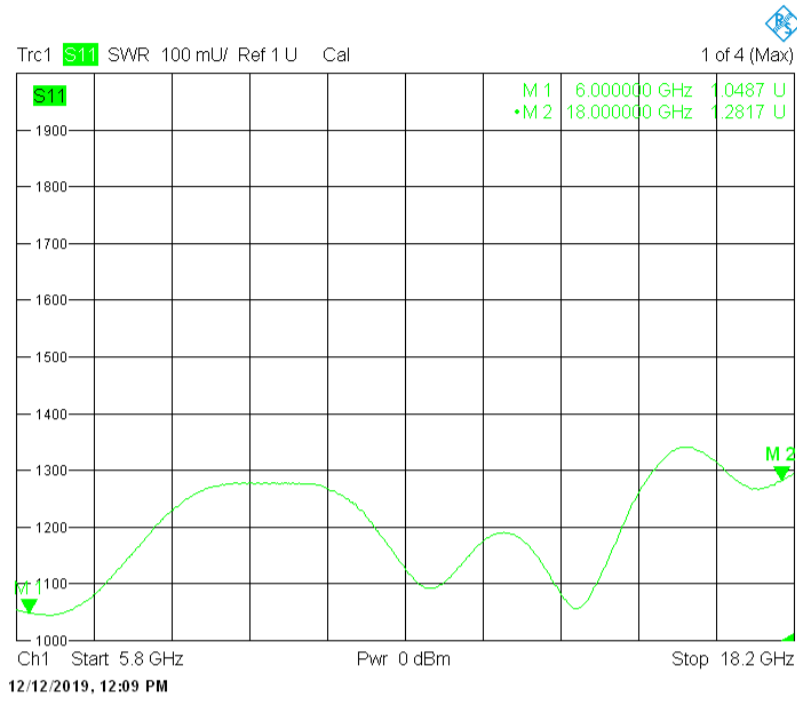

Output Port VSWR

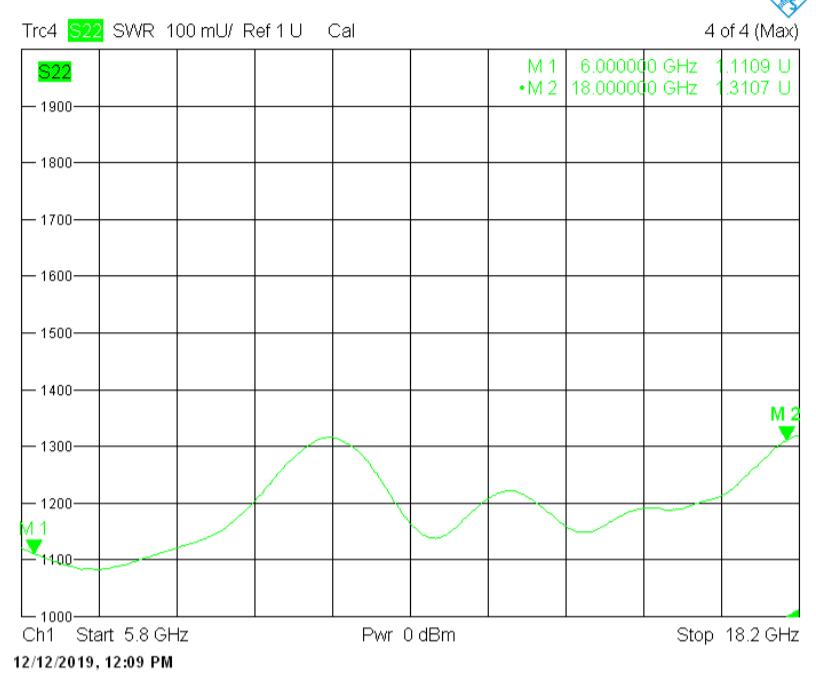

Insertion Loss

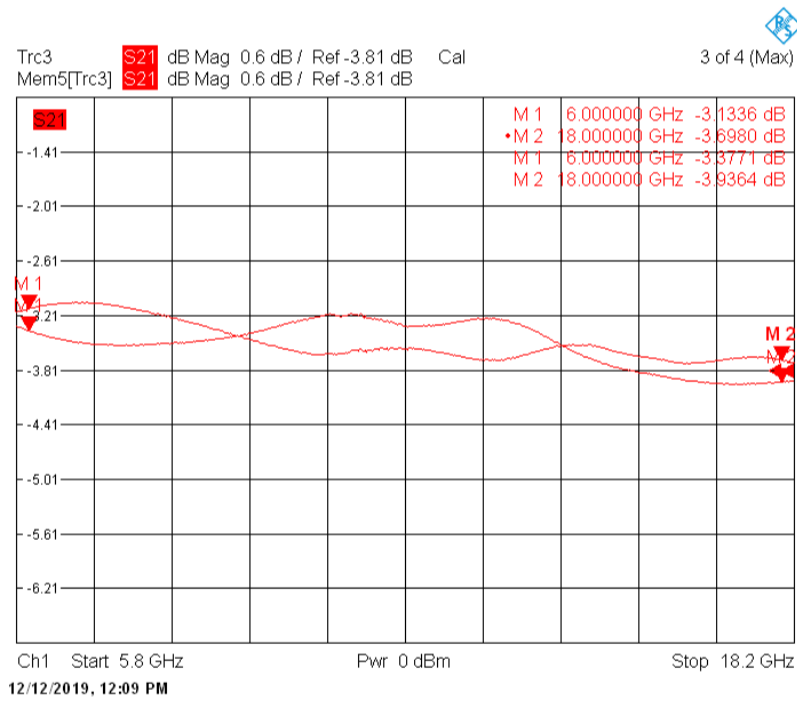

Isolator

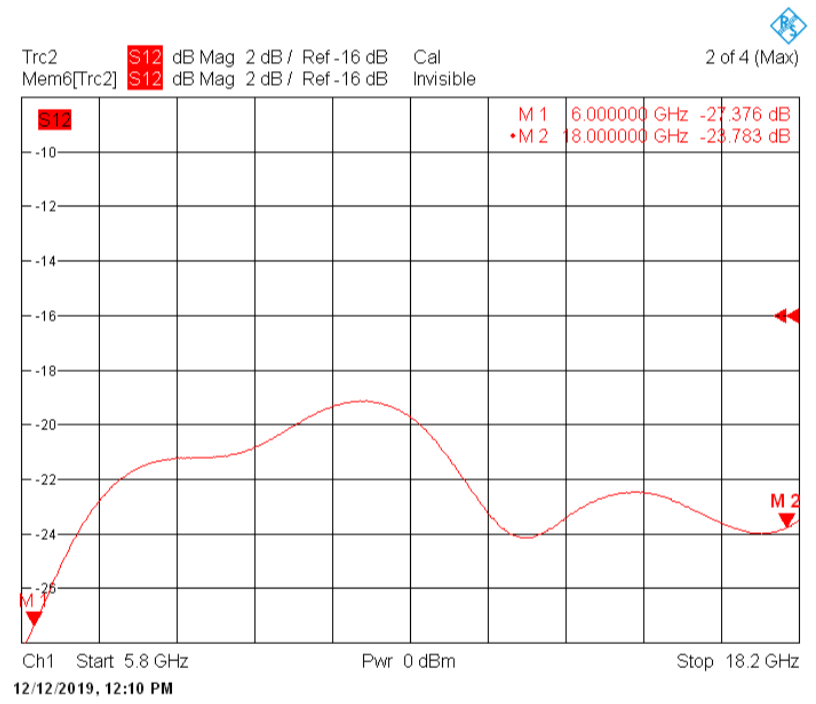

Amplitude Balance

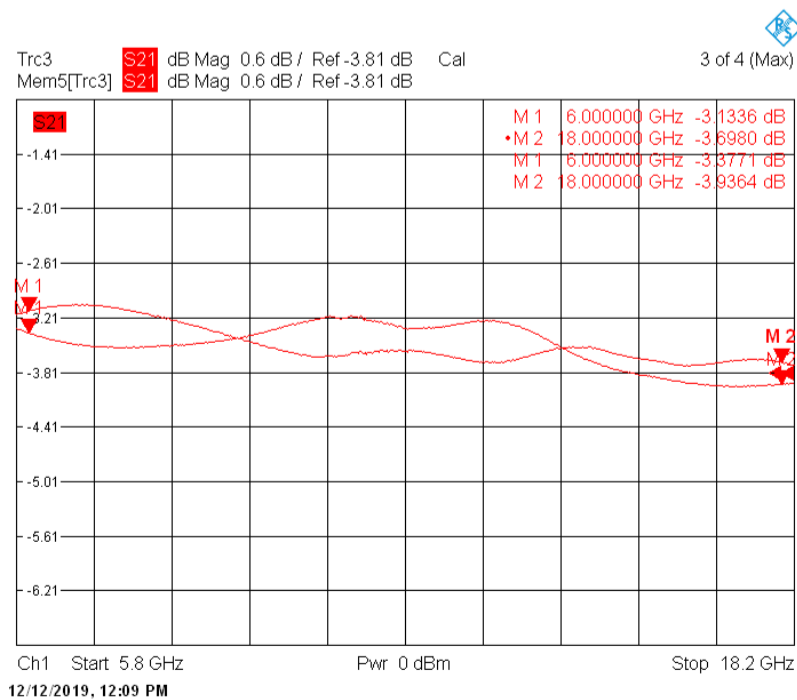

Phase Balance

