

Features

- Nominal Coupling 60dB
- Low Coupling Balance ± 2 dB
- Low Insertion Loss 0.5dB
- RoHS and REACH Compliant
- High Directivity 5dB

Electrical Specifications

Description	Units	Minimum	Typical	Maximum
Freq. Range	GHz	9.3		9.5
Nominal Coupling	dB		60	
Coupling Balance	dB		± 2	
Insertion Loss (True)	dB			0.5
Freq. Flatness	dB			0.7
Main Line VSWR				1.5
Secondary Line VSWR				1.5
Directivity	dB	5		
Input Power (CW)	W			100
Input Power (Peak)	KW			1
Impedance	Ohms		50	
Operating Temp.	°C	-45		+85

Special Requirements

Note

- Electronic Specification Note : Values at 25deg , sea level. Test indicators will deteriorate at high and low temperature ;
- Insertion Loss Including Nominal Coupling Loss - dB. ;
- Relative Humidity 5 to 95% ;

Mechanical Specifications

Dimension L*W*H	38.1*25.4*20 mm
Input Connector	N-Female Ni Plating
Output Connectors	N-Female Ni Plating
Weight	TBD g
Finishing	Paint Black
Environment	Nominal

Compliance Certifications

RoHS Compliant	✓
REACH Compliant	✓

CAD Drawing

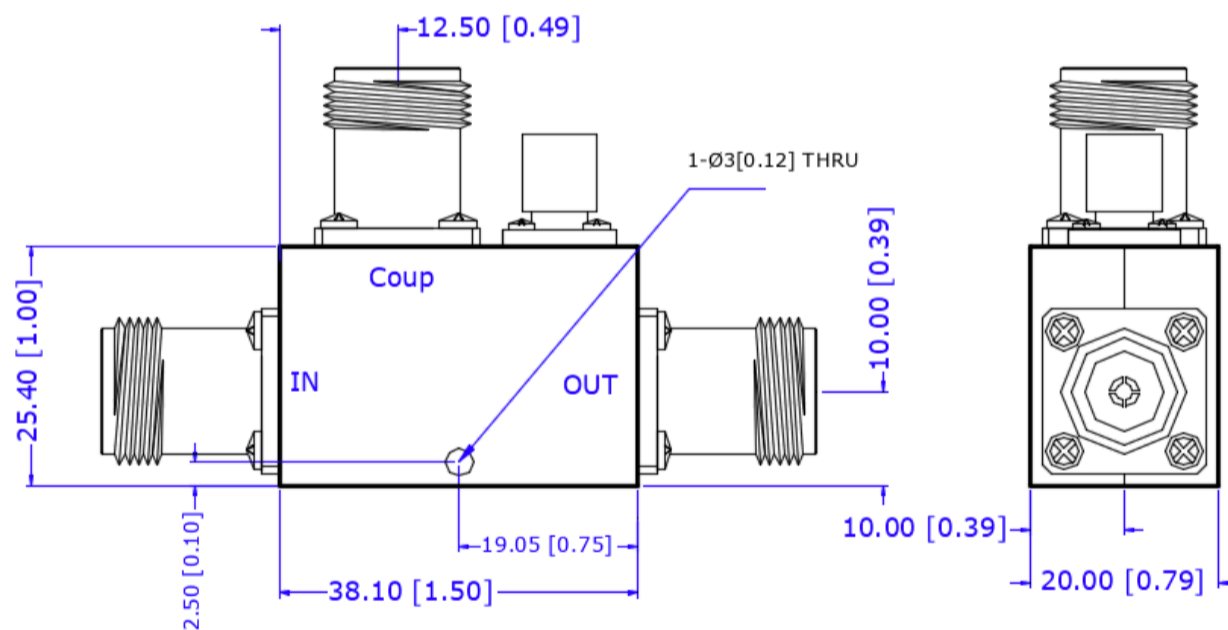

DC0030

Dimensions are in mm [Inches]
 Tolerances : Outline drawing: ±0.2 [0.008]
 Hole: ±0.2 [0.008]