

Features

- Nominal Coupling 30dB
- Low Coupling Balance ± 1.25 dB
- Low Insertion Loss 0.2dB
- RoHS and REACH Compliant
- High Directivity 25dB

Electrical Specifications

Description	Units	Minimum	Typical	Maximum
Freq. Range	GHz	1		2
Nominal Coupling	dB		30	
Coupling Balance	dB		± 1.25	
Insertion Loss (True)	dB			0.2
Freq. Flatness	dB			1.5
Main Line VSWR				1.15
Secondary Line VSWR				1.15
Directivity	dB	25	30	
Input Power (CW)	W			50
Input Power (Peak)	KW			3
Impedance	Ohms		50	
Operating Temp.	°C	-45		+85

Special Requirements

Note

- Electronic Specification Note : Values at 25deg , sea level. Test indicators will deteriorate at high and low temperature ;
- Insertion Loss Including Nominal Coupling Loss 0.004 dB. ;
- Relative Humidity 5 to 95% ;

Mechanical Specifications

Dimension L*W*H	45.2*13.9*10.67 mm
Input Connector	SMA-Female Stainless Steel
Output Connectors	SMA-Female Stainless Steel
Weight	TBD g
Finishing	Paint Black
Environment	Nominal

Compliance Certifications

RoHS Compliant	✓
REACH Compliant	✓

CAD Drawing

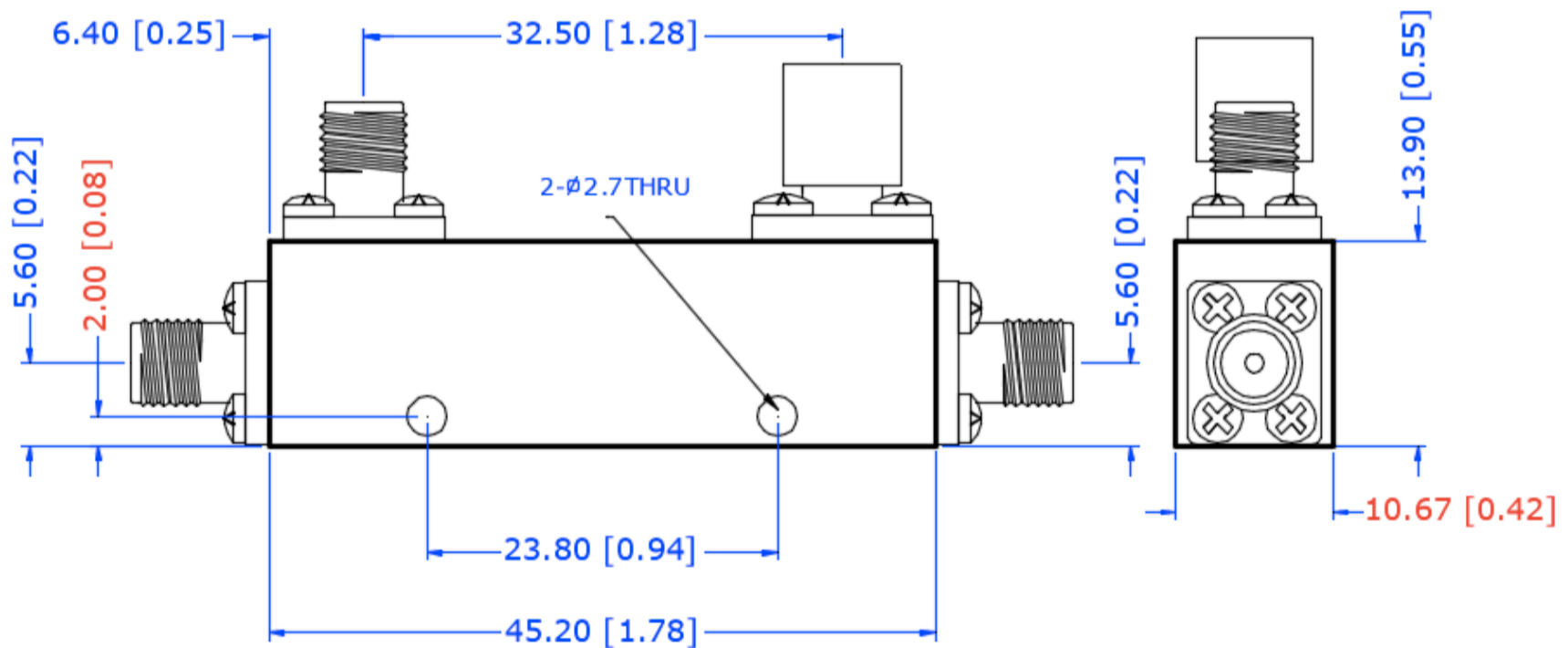

DC0064

Dimensions are in mm [Inches]
 Tolerances : Outline drawing: ±0.2 [0.008]
 Hole: ±0.2 [0.008]