

## Features

- Nominal Coupling 13dB
- Low Coupling Balance  $\pm 1$ dB
- Low Insertion Loss 1.5dB
- RoHS and REACH Compliant
- High Directivity 10dB

## Electrical Specifications

Description	Units	Minimum	Typical	Maximum
Freq. Range	GHz	12.5		44
Nominal Coupling	dB		13	
Coupling Balance	dB		$\pm 1$	
Insertion Loss (True)	dB			1.5
Freq. Flatness	dB			2.0
Main Line VSWR				1.7
Secondary Line VSWR				1.7
Directivity	dB	10		
Input Power (CW)	W			30
Input Power (Peak)	KW			0.5
Impedance	Ohms		50	
Operating Temp.	$^{\circ}$ C	-45		+85

## Special Requirements

## Note

- Electronic Specification Note : Values at 25deg , sea level. Test indicators will deteriorate at high and low temperature ;
- Insertion Loss Including Nominal Coupling Loss 0.22 dB. ;
- Relative Humidity 5 to 95% ;

### Mechanical Specifications

Dimension L*W*H	28*15*12.7 mm
Input Connector	2.4mm-Female Stainless Steel
Output Connectors	2.4mm-Female Stainless Steel
Weight	TBD g
Finishing	Paint Black
Environment	Nominal

### Compliance Certifications

RoHS Compliant	✓
REACH Compliant	✓

### CAD Drawing

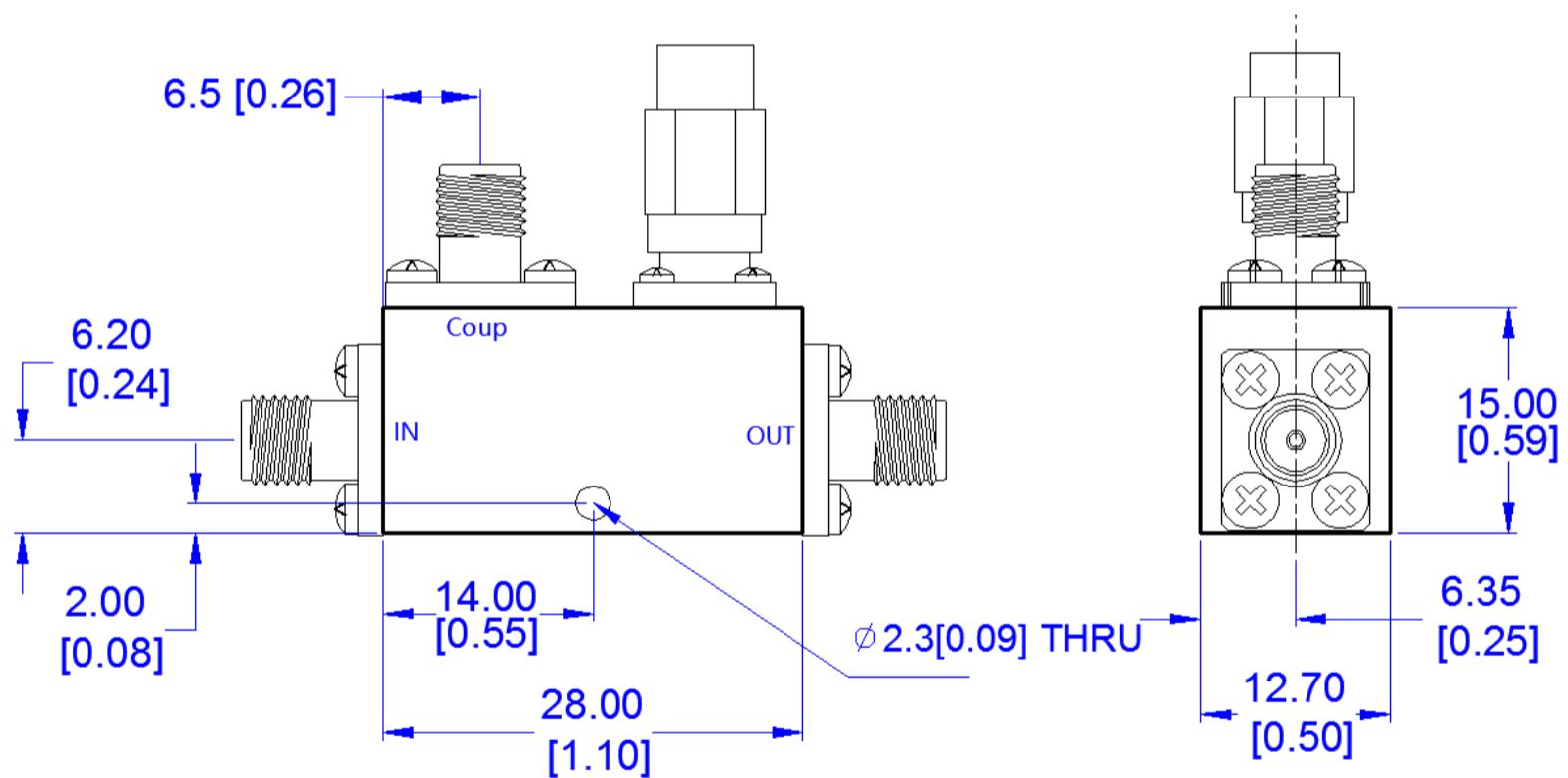

Dimensions are in mm [Inches]  
 Tolerances : Outline drawing:  $\pm 0.2$  [0.008]  
 Hole:  $\pm 0.2$  [0.008]