

Features

- Nominal Coupling 10dB
- Low Coupling Balance ± 1 dB
- Low Insertion Loss 1.1dB
- RoHS and REACH Compliant
- High Directivity 12dB

Electrical Specifications

Description	Units	Minimum	Typical	Maximum
Freq. Range	GHz	27		31
Nominal Coupling	dB		10	
Coupling Balance	dB		± 1	
Insertion Loss (True)	dB			1.1
Freq. Flatness	dB			1.0
Main Line VSWR				1.5
Secondary Line VSWR				1.5
Directivity	dB	12		
Input Power (CW)	W			30
Input Power (Peak)	KW			0.5
Impedance	Ohms		50	
Operating Temp.	°C	-45		+85

Special Requirements

Note

- Electronic Specification Note : Values at 25deg , sea level. Test indicators will deteriorate at high and low temperature ;
- Insertion Loss Including Nominal Coupling Loss 0.46 dB. ;
- Relative Humidity 5 to 95% ;

Mechanical Specifications

Dimension L*W*H	28*15*12.7 mm
Input Connector	2.92mm-Female Stainless Steel
Output Connectors	2.92mm-Female Stainless Steel
Weight	TBD g
Finishing	Paint Black
Environment	Nominal

Compliance Certifications

RoHS Compliant	✓
REACH Compliant	✓

CAD Drawing

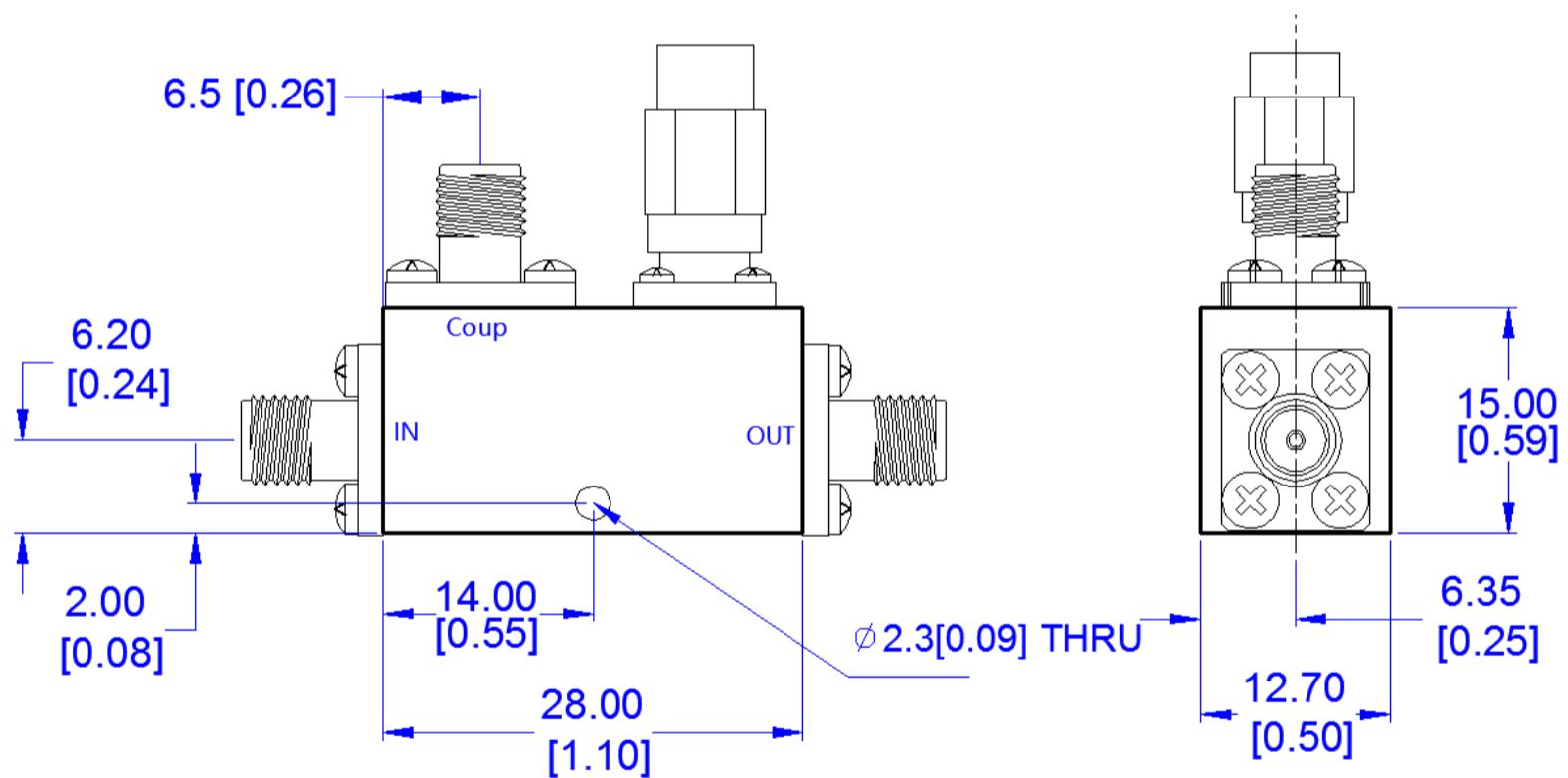

Dimensions are in mm [Inches]
 Tolerances : Outline drawing: ± 0.2 [0.008]
 Hole: ± 0.2 [0.008]